

Chapter Twelve

THERMODYNAMICS



MCQ I

12.1 An ideal gas undergoes four different processes from the same initial state (Fig. 12.1). Four processes are adiabatic, isothermal, isobaric and isochoric. Out of 1, 2, 3 and 4 which one is adiabatic.

- (a) 4
- (b) 3
- (c) 2
- (d) 1

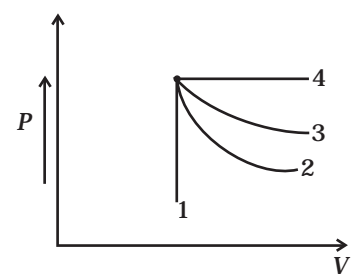

Fig. 12.1

12.2 If an average person jogs, hse produces 14.5×10^3 cal/min. This is removed by the evaporation of sweat. The amount of sweat evaporated per minute (assuming 1 kg requires 580×10^3 cal for evaporation) is

- (a) 0.25 kg
- (b) 2.25 kg
- (c) 0.05 kg
- (d) 0.20 kg

12.3 Consider P - V diagram for an ideal gas shown in Fig 12.2.

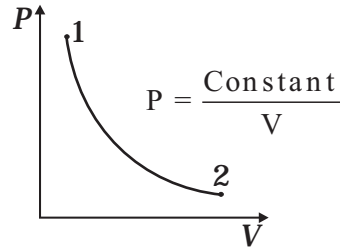

Fig. 12.2

Out of the following diagrams (Fig. 12.3), which represents the T - P diagram?

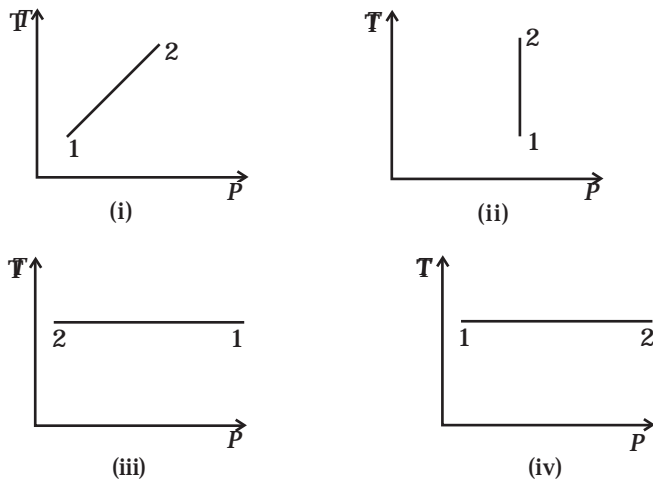

Fig. 12.3

- (a) (iv)
- (b) (ii)
- (c) (iii)
- (d) (i)

12.4 An ideal gas undergoes cyclic process ABCDA as shown in given P - V diagram (Fig. 12.4).

The amount of work done by the gas is

- (a) $6P_0V_0$
- (b) $-2P_0V_0$
- (c) $+2P_0V_0$
- (d) $+4P_0V_0$

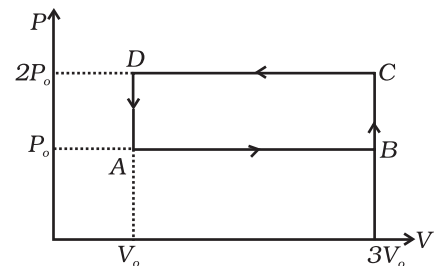

Fig 12.4

12.5 Consider two containers A and B containing identical gases at the same pressure, volume and temperature. The gas in container A is compressed to half of its original volume isothermally while the gas in container B is compressed to half of its original value adiabatically. The ratio of final pressure of gas in B to that of gas in A is

- (a) $2^{\gamma-1}$
 (b) $\left(\frac{1}{2}\right)^{\gamma-1}$
 (c) $\left(\frac{1}{1-\gamma}\right)^2$
 (d) $\left(\frac{1}{\gamma-1}\right)^2$

12.6 Three copper blocks of masses M_1 , M_2 and M_3 kg respectively are brought into thermal contact till they reach equilibrium. Before contact, they were at T_1 , T_2 , T_3 ($T_1 > T_2 > T_3$). Assuming there is no heat loss to the surroundings, the equilibrium temperature T is (s is specific heat of copper)

- (a) $T = \frac{T_1 + T_2 + T_3}{3}$
 (b) $T = \frac{M_1 T_1 + M_2 T_2 + M_3 T_3}{M_1 + M_2 + M_3}$
 (c) $T = \frac{M_1 T_1 + M_2 T_2 + M_3 T_3}{3(M_1 + M_2 + M_3)}$
 (d) $T = \frac{M_1 T_1 s + M_2 T_2 s + M_3 T_3 s}{M_1 + M_2 + M_3}$

MCQ II

12.7 Which of the processes described below are irreversible?

- (a) The increase in temperature of an iron rod by hammering it.
 (b) A gas in a small container at a temperature T_1 is brought in contact with a big reservoir at a higher temperature T_2 which increases the temperature of the gas.
 (c) A quasi-static isothermal expansion of an ideal gas in cylinder fitted with a frictionless piston.

(d) An ideal gas is enclosed in a piston cylinder arrangement with adiabatic walls. A weight W is added to the piston, resulting in compression of gas.

12.8 An ideal gas undergoes isothermal process from some initial state i to final state f . Choose the correct alternatives.

- (a) $dU = 0$
- (b) $dQ = 0$
- (c) $dQ = dU$
- (d) $dQ = dW$

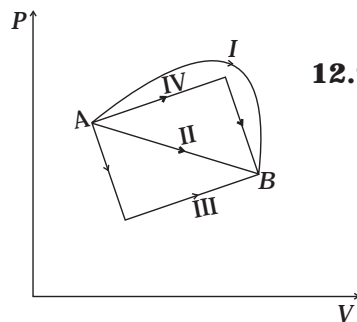

Fig. 12.5

12.9 Figure 12.5 shows the P - V diagram of an ideal gas undergoing a change of state from A to B . Four different parts I, II, III and IV as shown in the figure may lead to the same change of state.

- (a) Change in internal energy is same in IV and III cases, but not in I and II.
- (b) Change in internal energy is same in all the four cases.
- (c) Work done is maximum in case I
- (d) Work done is minimum in case II.

12.10 Consider a cycle followed by an engine (Fig. 12.6)

- 1 to 2 is isothermal
- 2 to 3 is adiabatic
- 3 to 1 is adiabatic

Such a process does not exist because

- (a) heat is completely converted to mechanical energy in such a process, which is not possible.
- (b) mechanical energy is completely converted to heat in this process, which is not possible.
- (c) curves representing two adiabatic processes don't intersect.
- (d) curves representing an adiabatic process and an isothermal process don't intersect.

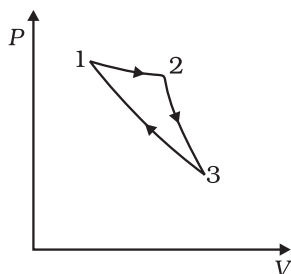

Fig. 12.6

12.11 Consider a heat engine as shown in Fig. 12.7. Q_1 and Q_2 are heat added to heat bath T_1 and heat taken from T_2 in one cycle of engine. W is the mechanical work done on the engine.

If $W > 0$, then possibilities are:

- (a) $Q_1 > Q_2 > 0$
- (b) $Q_2 > Q_1 > 0$
- (c) $Q_2 < Q_1 < 0$
- (d) $Q_1 < 0, Q_2 > 0$

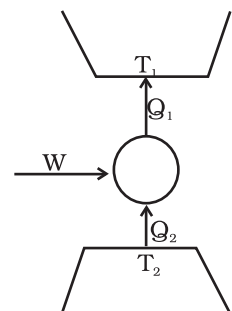

Fig. 12.7

VSA

- 12.12** Can a system be heated and its temperature remains constant?
- 12.13** A system goes from P to Q by two different paths in the P - V diagram as shown in Fig. 12.8. Heat given to the system in path 1 is 1000 J. The work done by the system along path 1 is more than path 2 by 100 J. What is the heat exchanged by the system in path 2?
- 12.14** If a refrigerator's door is kept open, will the room become cool or hot? Explain.
- 12.15** Is it possible to increase the temperature of a gas without adding heat to it? Explain.
- 12.16** Air pressure in a car tyre increases during driving. Explain.

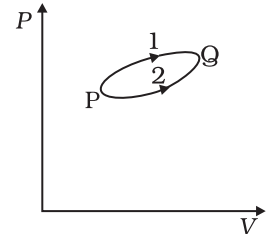

Fig. 12.8

SA

- 12.17** Consider a Carnot's cycle operating between $T_1 = 500\text{K}$ and $T_2 = 300\text{K}$ producing 1 k J of mechanical work per cycle. Find the heat transferred to the engine by the reservoirs.
- 12.18** A person of mass 60 kg wants to lose 5kg by going up and down a 10m high stairs. Assume he burns twice as much fat while going up than coming down. If 1 kg of fat is burnt on expending 7000 kilo calories, how many times must he go up and down to reduce his weight by 5 kg?
- 12.19** Consider a cycle tyre being filled with air by a pump. Let V be the volume of the tyre (fixed) and at each stroke of the pump $\Delta V (\ll V)$ of air is transferred to the tube adiabatically. What is the work done when the pressure in the tube is increased from P_1 to P_2 ?
- 12.20** In a refrigerator one removes heat from a lower temperature and deposits to the surroundings at a higher temperature. In this process, mechanical work has to be done, which is provided by an electric motor. If the motor is of 1kW power, and heat is transferred from -3°C to 27°C , find the heat taken out of the refrigerator per second assuming its efficiency is 50% of a perfect engine.

12.21 If the co-efficient of performance of a refrigerator is 5 and operates at the room temperature (27 °C), find the temperature inside the refrigerator.

12.22 The initial state of a certain gas is (P_i, V_i, T_i) . It undergoes expansion till its volume becomes V_f . Consider the following two cases:

- (a) the expansion takes place at constant temperature.
- (b) the expansion takes place at constant pressure.

Plot the P - V diagram for each case. In which of the two cases, is the work done by the gas more?

LA

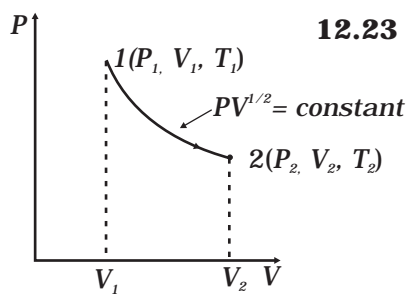

Fig. 12.9

12.23 Consider a P - V diagram in which the path followed by one mole of perfect gas in a cylindrical container is shown in Fig. 12.9.

- (a) Find the work done when the gas is taken from state 1 to state 2.
- (b) What is the ratio of temperature T_1/T_2 , if $V_2 = 2V_1$?
- (c) Given the internal energy for one mole of gas at temperature T is $(3/2) RT$, find the heat supplied to the gas when it is taken from state 1 to 2, with $V_2 = 2V_1$.

12.24 A cycle followed by an engine (made of one mole of perfect gas in a cylinder with a piston) is shown in Fig. 12.10.

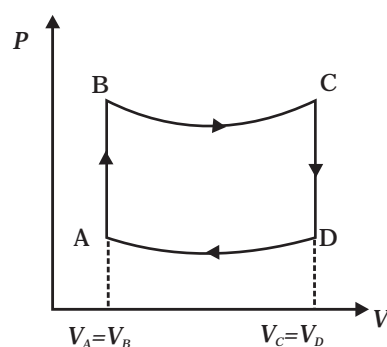

Fig. 12.10

- A to B : volume constant
- B to C : adiabatic
- C to D : volume constant
- D to A : adiabatic
- $V_C = V_D = 2V_A = 2V_B$

- (a) In which part of the cycle heat is supplied to the engine from outside?
- (b) In which part of the cycle heat is being given to the surrounding by the engine?
- (c) What is the work done by the engine in one cycle? Write your answer in term of P_A, P_B, V_A .
- (d) What is the efficiency of the engine?

$[\gamma = 5/3 \text{ for the gas}], (C_v = \frac{3}{2}R \text{ for one mole})$

12.25 A cycle followed by an engine (made of one mole of an ideal gas in a cylinder with a piston) is shown in Fig. 12.11. Find heat exchanged by the engine, with the surroundings for each section of the cycle. ($C_v = (3/2)R$)

- AB : constant volume
- BC : constant pressure
- CD : adiabatic
- DA : constant pressure

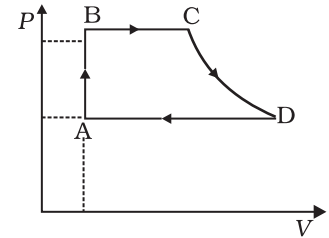

Fig. 12.11

12.26 Consider that an ideal gas (n moles) is expanding in a process given by $P = f(V)$, which passes through a point (V_o, P_o) . Show that the gas is absorbing heat at (P_o, V_o) if the slope of the curve $P = f(V)$ is larger than the slope of the adiabat passing through (P_o, V_o) .

12.27 Consider one mole of perfect gas in a cylinder of unit cross section with a piston attached (Fig. 12.12). A spring (spring constant k) is attached (unstretched length L) to the piston and to the bottom of the cylinder. Initially the spring is unstretched and the gas is in equilibrium. A certain amount of heat Q is supplied to the gas causing an increase of volume from V_o to V_1 .

- (a) What is the initial pressure of the system?
- (b) What is the final pressure of the system?
- (c) Using the first law of thermodynamics, write down a relation between Q, P_a, V, V_o and k .

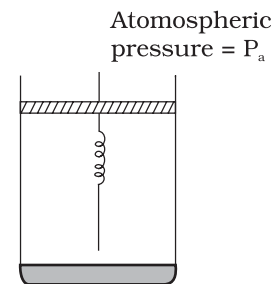

Fig. 12.12